

Home Energy Efficiency Kit

Instruction Guide



WOLLONGONG CITY LIBRARIES

Produced By
(E) EnviroShop
Energy • Sustainability • Efficiency

This tool kit is designed to help you identify issues that are affecting the energy efficiency of your home.

Each tool is designed to give information about some important aspects of your home's efficiency, which can help you to work out what steps you can take to reduce how much energy you use, reduce your greenhouse gas emissions, and save money.

Energy efficiency and climate change

Australian households generate at least one-fifth of Australia's greenhouse gases – more than 18 tonnes per household each year¹. Averages provide only part of the picture because households can vary greatly in the amount of greenhouse gas emissions, which are the emissions causing rapid climate change. Making our homes more efficient, and making the shift to renewable forms of energy, are important actions we can all take to reduce our carbon emissions and tackle climate change. Offering these kits to residents via our libraries is part of this commitment.

Resources

This guide has been developed to help you understand exactly how to use this tool. There are also some great resources available online if you want to learn more, but be careful that they apply to your situation, particularly your local climate. Many of the common resources online are aimed at snow zones like the Northern parts of Europe and the Americas and they aren't necessarily applicable to our climate.

If you would like to learn more, here are some local resources that are worth referring to:

Sustainability Victoria's Household Energy Action Guide provides information about how to be more energy efficient in your home, with links to key local resources.

www.sustainability.vic.gov.au/You-and-your-home/Save-energy

The **EnviroShop** is a local business based in Northcote, Victoria. They have a wide range of products and services to help you live more sustainably and as well as compiling this tool kit and instruction guide, have made available this great resource to help you identify and address wasted energy and resources in your home.

¹ EPA Victoria, Australian Greenhouse Calculator - Research Centre - Households and GHG emissions, accessed July 2023, <https://apps.epa.vic.gov.au/AGC/r_emissions.html#!>

enviroshop.com.au/pages/how-to-make-your-home-more-energy-efficient

Your Home Technical Manual is a Federal Government resourced guide to environmentally sustainable homes. Because it's local it is relevant to our climates and local building regulations. It is primarily aimed at new homes or renovations but the majority of the information can also be applied to an existing house. It is available for free online or you can purchase a printed book.

www.yourhome.gov.au/

Renew is a national, not-for-profit organisation that inspires, enables and advocates for people to live sustainably in their homes and communities. Their website, forums and magazines are a goldmine of information about all aspects of living sustainably. You can also sign up for a membership to help support them and subscribe to their magazines.

renew.org.au/

My Efficient Electric Home is a popular group on Facebook dedicated to helping people get off gas and make their homes more efficient. At the time of writing they have around 70,000 members and there is a vast archive of questions and answers in the group. If you can't find the answer already there then you can ask and you'll likely get a range of expert opinions.

www.facebook.com/groups/MyEfficientElectricHome/

Energy Saving Thermometer

This is just a simple old-fashioned thermometer but with the addition of marked temperature ranges for several different parts of your home. There are recommended zones for your hot water, room temperatures, fridge and freezer. Using it is very simple.

Hot Water

Pick a tap that has the shortest pipe run to the hot water system (the one that gets hot water to the tap fastest, it may not physically be the closest in an old house). Run the hot water until it is as its hottest, then hold the bottom end of the thermometer under the running water for about 30 seconds.

Water that is too hot wastes energy and causes additional strain on your hot water system, reducing its life. Water that isn't hot enough (less 60 degrees Celsius in the tank) has the potential to grow pathogens like legionella. There may be a drop of a few degrees over a long pipe run though.

Energy Saving Tip

If the hot water temperature is outside the ideal zone indicated, then you can usually adjust the thermostat on your hot water system up or down as required. If you have a storage system it can take quite a while for the tank temperature to change so you may need to wait a few hours or even until the next day to check again. If you have an instantaneous system it should change quickly.

If your hot water system was installed in the last 10 years or so it may have a tempering valve fitted which mixes cold water with the hot water to prevent scalding, in which case the water temperature is unlikely to be more than 55 degrees. You may be able to check the temperature of the water directly at

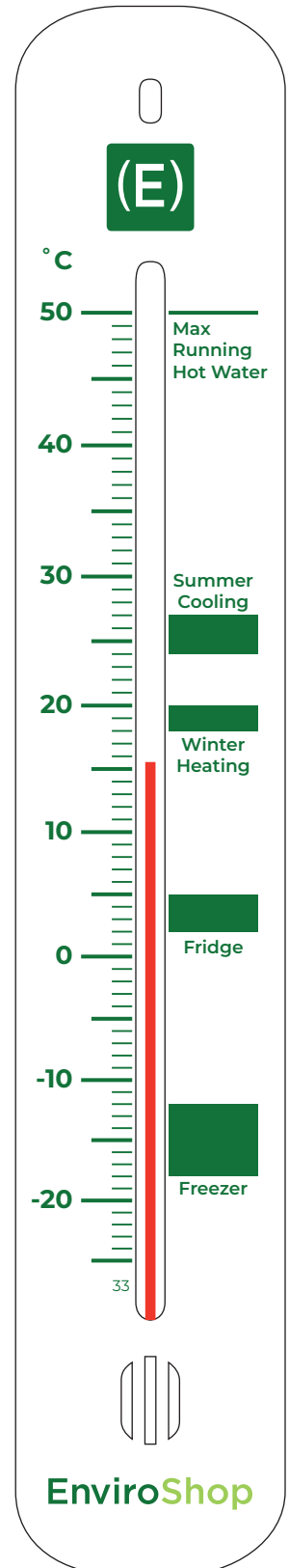

the tank by releasing a bit of water from the PTR valve and measuring that, but be very careful not to scald yourself.

Room Temperatures

There are ideal temperature ranges indicated for summer cooling and winter heating. The majority of people will be comfortable in these temperature ranges assuming there aren't other issues like draughts or radiant heat causing them to feel uncomfortable. Measure the temperature in your living spaces and adjust your heating and cooling if necessary. If you're not comfortable in these temperature ranges you'll need to do more research into why (It could be as simple as dressing for the season).

Fridge and Freezer

Leave the thermometer in your (closed) fridge or freezer for a few minutes and then read the temperature. If it's warmer than the indicated range then your food is in danger of spoiling earlier than it should. If it's cooler then you're using more energy than you need to.



Energy Saving Tip

Adjust the thermostat in your fridge and freezer up or down until it's in the recommended zone. It may take a few hours to stabilise to the new temperature. If it won't go high or low enough then it's due for a visit from a service person to investigate why.

Water Flow Measuring Cup

The water flow measuring cup is a simple device for measuring how much water your taps, shower etc. are using in litres per minute.

Fitting a flow restrictor to a tap or a low-flow shower head can save lots of water and especially energy if it's hot water. It can also save you from running out of hot water by using less water for the same length of shower.



How to measure tap flow rate

STEP 1

Turn the tap on full, hold the cup under it with the handles pushed together until overflowing.

IMPORTANT: Aerators attached to the end of the spout must remain completely immersed in the water inside the cup during this test.



STEP 2

Slowly pull the handles apart. There will be a point where the water level stops going up and overflowing and stays fairly level. If it's dropping then push the handles back together a little.



STEP 3

Once the cup is full to the top, and staying level, turn off the tap and look at the number on the side of the cup where the handle is pointing. This number will give you the litres per minute of flow.



An efficient tap should have a flow rate of less than 9 litres per minute (L/m) and it can be as low as 2 L/m with a very efficient tap. Kitchen and laundry sinks may require flows at the higher end of the scale, while bathroom basins etc. should be towards the lower end.

How to measure shower flow rate

Measuring the flow rate of a shower can be a bit trickier because of the wider water flow.

You might be able to improvise a wide funnel with a sheet of plastic (get someone to help hold everything!) to channel the water into the cup.

Otherwise you can use a big measuring jug or mark a bucket in litres and turn the tap on for 30 seconds and then double the amount of water measured to get the result in L/m. (maybe get someone else to use the stopwatch on their phone while you hold everything)

For water-using appliances such as washing machines, dishwashers etc., they should have a star-rating label indicating how much water is used per load. If the label has been removed you can look up the model on the official database here: <https://www.waterrating.gov.au/>

Energy Saving Tip

You can retrofit most newer taps with flow restrictors or aerators. Not much can be done about older taps apart from being aware they are using a lot of water and changing your behaviour. When renovating or building make sure you compare flow rates on products.

Energy Saving Tip

When you need to purchase a new appliance, remember: the more stars it has, the less water and energy it will use, and the more money it will save you over time.

Power-Mate Lite Energy Meter

The Power-Mate Lite is an energy meter that measures how much electrical power is being used by a device that is plugged into it. It is very handy for educating yourself about how much energy different appliances are using and possibly identifying the culprit behind high energy bills.

It can't measure the energy use of hard-wired devices like lighting, electric hot water systems etc., but it can measure appliances such as your wall heater, stereo system or clothes dryer. By educating yourself about energy use of these kinds of appliances you are better placed to be able to understand how much these devices are using by estimation



Did you know?

Electrical energy is usually measured in kWh, or kilo-Watt-hours and this is usually what appears on your electricity bill. One kWh is simply 1,000 watts being used for one hour. The maths is not hard to work out, you just need to convert power to kW and time to hours.

10 Watts = 0.01kW

100 Watts = 0.1kW

1000 Watts = 1kW

Multiply the kW by how many hours it is used for (e.g. a computer used 8 hours a day) E.g. $0.1\text{kW} \times 8 \text{ hours} = 0.8\text{kWh}$

How to use it to measure an appliance

STEP 1

With the power point switched off, plug in the Power-Mate to a power point and then plug your appliance that you want to measure into the Power-Mate socket.

Turn on the power switch on the power point. Hold (long press) the **RUN** button and wait until the screen displays “**CONFIRM CLR DATA?**”, then click (short press) the **RUN** button to select “**YES**”.

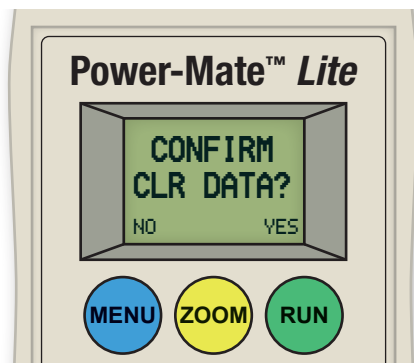

STEP 2

Click the **RUN** button to start the measuring the energy usage of the appliance.

A flashing ► will appear in the top right corner of the screen to show that the Power-Mate is now measuring the appliance’s energy usage.

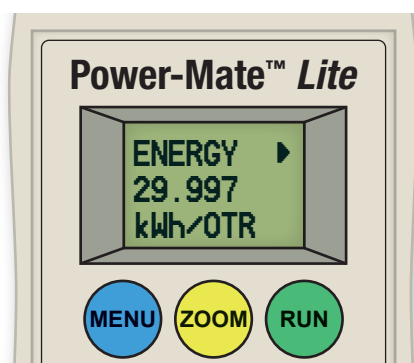

STEP 3

You can see how much your appliance costs to run by clicking the **MENU** button until you are in the **COST** screen. This shows the real, hourly, quarterly, and yearly cost (\$) to run the appliance.

The Real cost is the cost to run the appliance since the measurement started. This is useful to find out the cost per use. Hourly, quarterly, and yearly costs are based on constant usage of the appliance over that time period.

Click the **ZOOM** button to toggle between real, hourly, quarterly, and yearly cost lines. To magnify the figures, hold the **ZOOM** button. Click the **ZOOM** button to toggle between each magnified line, and hold the **ZOOM** button to revert back to the normal view.

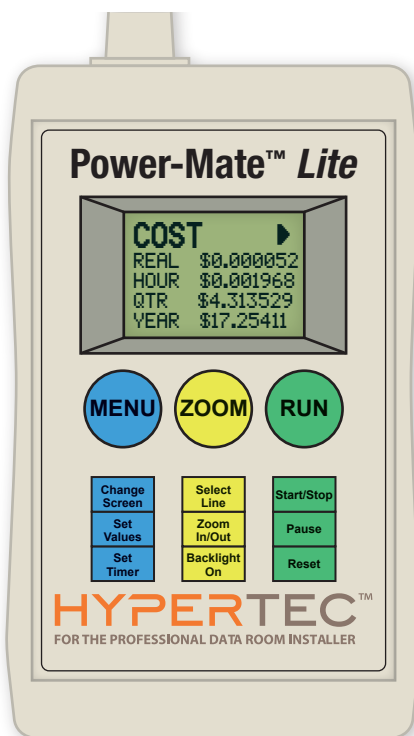

STEP 4

To see the greenhouse gas emissions and energy used by the appliance, click the **MENU** button. The real, hourly, quarterly, and yearly greenhouse gas emissions (kg CO₂-e) and energy consumed (kWh) by the appliance are shown respectively.

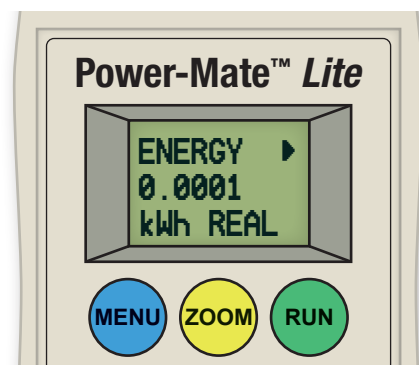

The **ZOOM** button can be used to toggle between and magnify lines.

STEP 5

Write down your measurements to keep track of all your appliances. You can measure an appliance while it's running and then while it is in standby mode to see how much you'll save if you switch it off at the wall after you have finished using it. Just remember to clear the data between each reading (see STEP 1 or STEP 6).

STEP 6

Click the **RUN** button to stop the measurement. A flashing **||** will appear in the top right corner of the screen to show that the Power-Mate has been paused/stopped.

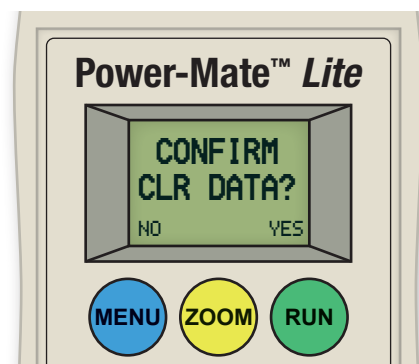

Hold the **RUN** button and then click the **RUN** button to select "**YES**" to "**CONFIRM CLR DATA?**". You are now ready to measure your next appliance.

STEP 6

Switch off appliances that are using energy when they're not being used and save money on your next electricity bill!

You can now use the information you have learned about your appliances to use them less and switch them off at the wall. If shopping for new appliances, you can also use the Power-Mate to compare the energy use (kWh) of your current appliance and the energy rating label of new products to make sure you buy something more efficient to run.

How to understand the Power-Mate reading

Watts (W) are a measure of power, or how quickly electricity is being used. Power is probably the most important aspect to understand in energy efficiency.

The total amount of energy actually used is the power multiplied by the length of time it is used.

A small item run 24 hours a day (e.g. internet router) can consume quite a lot of energy. While a very high power item only run for a few minutes (e.g. .kettle) won't use much energy.

For example, an internet router that consumes 10 Watts (0.01kW) and is switched on 24 hours a day will use $0.01 \times 24 = 0.24\text{kWh}$ per day.

A kettle that uses 2400W and is on for 5 minutes ($5 \div 60$ minutes in an hour = 0.08333) will use $2.4 \times 0.08 = 0.2\text{kWh}$ (nearly the same as the modem being on all day).

Multiply this by lots of large and small appliances around your house and you have your power bill.

How to estimate your appliances' energy use

For simple devices that have fairly consistent energy use you can simply measure the watts and estimate how many hours a day it is used to work out total energy consumption.

Some appliances such as a fridge or plug-in heater will switch on and off (to ensure they stay at the correct temperature). To get an accurate idea of their energy use you need to monitor them over several hours or days. The Power-Mate is capable of logging energy use over time. If you want to do this it's best to refer to the manual (included in the kit). If it's not in the kit it is easily found online, just search for Power-Mate Lite manual.

Make sure you measure as many appliances as you can. Sometimes the biggest energy user is a fridge or freezer kept in the garage. It's often an older model that's been moved out there when you've upgraded in the kitchen and can be subject to extremes of heat in summer.

Many appliances these days come with an energy star rating which should have estimates of typical energy use. If the label has been

removed from yours you may be able to find it on the official database here: <https://www.energyrating.gov.au/>

The more appliances you measure, the more of a feel you have for what each one uses and where your household energy is going. (e.g. don't stress about the kids leaving lights on if it's a 5W LED, do stress about it if it's 6 × 50W halogen downlights!)

Energy Saving Tip

When you need to purchase a new appliance, remember: the more stars it has, the less energy it will use, and the more money it will save you over time. Also, the more water efficient it is (e.g. for a washing machine) the less energy it will need to heat the water when you are doing a warm wash. Remember however, that the best way to save energy when washing clothes is to wash in cold water.

Additional Instructions

Enter your own electricity cost

The electricity cost programmed into the Power-Mate may not be the same as what you are currently paying. If you wish to change the electricity cost and program it to use your current rate, follow these steps:

1. Check your electricity bill for your current electricity cost (c/kWh).
2. Click the **MENU** button (a few times if required) until you are in the **COST** screen.
3. Hold the **MENU** button in the **COST** screen until the **SET COST** screen appears.
4. Click the **ZOOM** button to change the flashing number to alter the electricity cost. Click the **RUN** button to select the next digit.
5. Once you are finished updating the costs, click the **MENU** button to exit and return to the **MENU** screens.

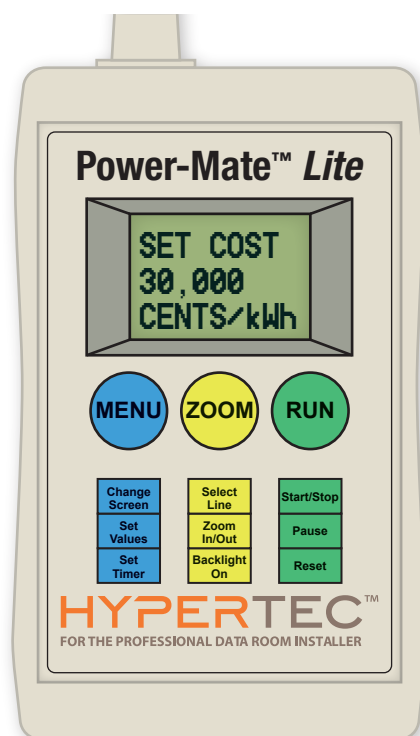

Set an automated measurement time

For most appliances, a few seconds is enough time to get an accurate power use reading. However, appliances that operate on temperature cycles such as fridges and freezers will need to be plugged into the Power-Mate for at least 24 hours for an accurate reading: Appliances that use start-up power such as laptops, PCs, coffee machines, printers, and phones should be measured after their start-up routine.

To set an automated measurement time follow these steps:

1. Click the **MENU** button (a few times if required) until you are in the **RUNTIME/ENDTIME** screen.
2. Hold the **MENU** button in the **RUNTIME/ENDTIME** screen until the **TIMER DURATION** screen appears.
3. Click the **ZOOM** button to select your desired run time.
4. Click the **RUN** button to load the selected run time.
5. Click the **MENU** button to exit and return to the **MENU** screens.
6. You can skip this step or select “**NOT SET**”. In this case, you will need to manually stop the Power-Mate’s measurement once you are finished by clicking the **RUN** button.

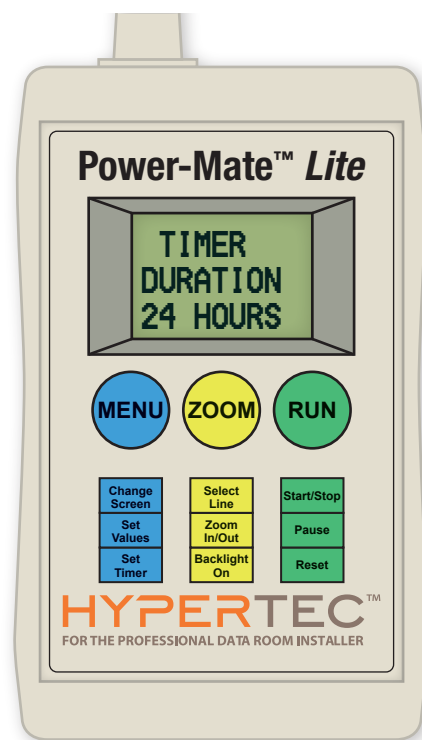

WARNINGS

The Power-Mate is only to be used by an adult or under adult supervision — take care to avoid injury or damage when using the Power-Mate by following these instructions:

- Turn power off at the wall before connecting or disconnecting the Power-Mate.
- Do not use the Power-Mate if the cord of either the Power-Mate or the appliance you are testing is damaged.
- Do not allow the Power-Mate to get wet or expose it to excessive heat.
- The Power-Mate has a maximum capacity of 10 amps. Make sure the appliance you are measuring is under 10 amps — the current or power rating is usually written on the label. If a “**WARNING, OVERLOAD**” message appears, turn the power off at the wall and disconnect the Power-Mate immediately.

Protech QM7410 IR Non-contact Thermometer

The Protech QM7410 IR (InfraRed) Non-contact Thermometer helps you find those cold and hot spots in your home to help you identify missing insulation, draught sources, and electronic devices using lots of energy.

By taking spot measurements of different areas of your home, you can work out the next steps you need to make to make your home a cosy one by adding extra insulation, plugging up the gaps and holes that lead to draughts, and save money by finding electronic devices that don't need to be running.

With a -50°C to 500°C temperature range and a laser point to accurately take measurements, a IR Non-contact thermometer is a very useful tool in the Energy Efficiency Tool Kit.



Product Description

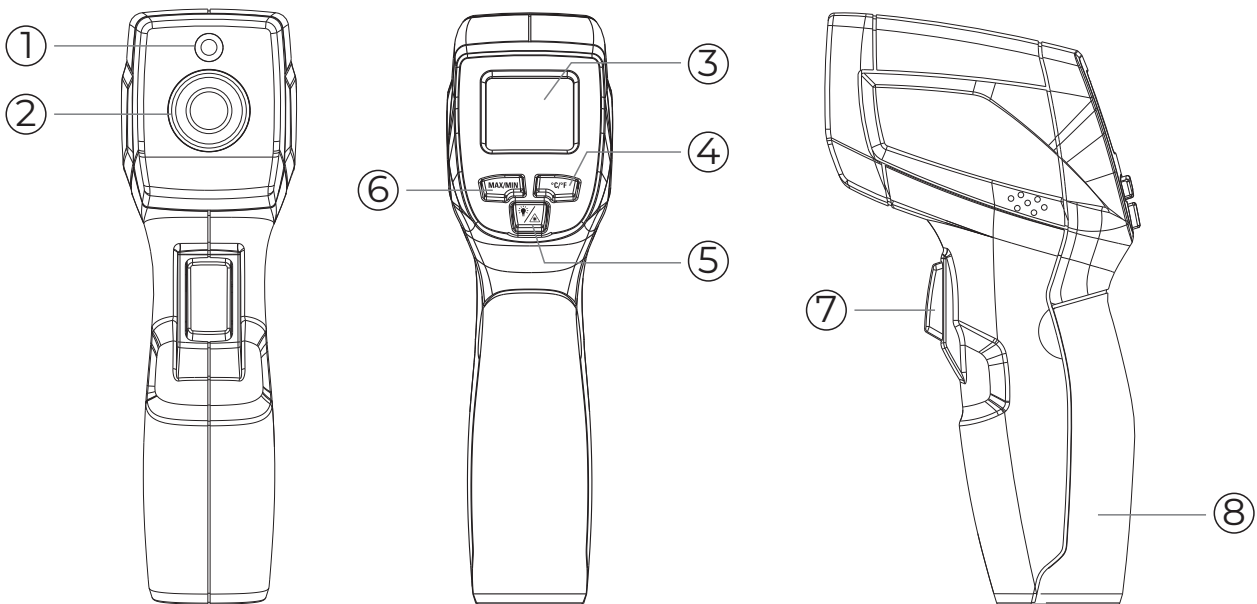

1. Laser
2. Infrared Sensor
3. Display Screen
4. $^{\circ}\text{C}/^{\circ}\text{F}$ Button

5. Laser/Backlight Button
6. Max/Min Button
7. Power On/Measure Button
8. Battery Cover

LCD Interface

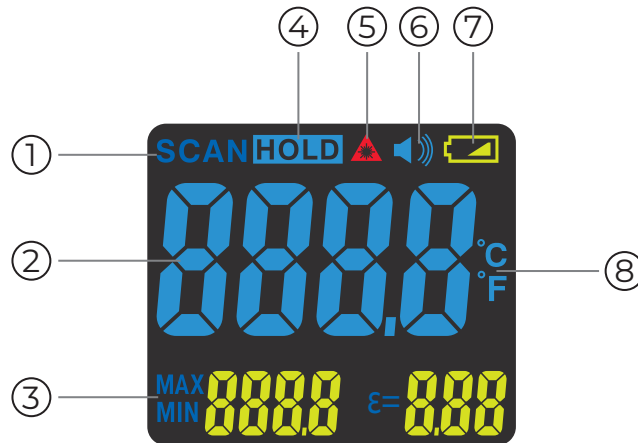

- | | |
|----------------------------------|---------------------|
| 1. Scan Symbol | 5. Laser On Symbol |
| 2. Measure Data | 6. Buzzer Symbol |
| 3. Temperature Value for Min/Max | 7. Low Power Symbol |
| 4. Data Hold Symbol | 8. C°/F° Symbol |

How to check 'spot size'

As you move away from the object you're measuring, the IR sensor will capture an increasingly larger area. The 'measurement distance to spot size ratio' of this non-contact thermometer is 12:1.

For example: If you measure a surface 36 cm away, the spot size will be 3 cm in diameter. At a 12 metre distance, the spot size will be 1 metre in diameter.

TIP: For best results, ensure the area you are measuring is at least twice the area of your spot size. Bring the temperature gun closer to your target if needed to check a specific area. The laser pointer makes it easy to know what you're pointing at.

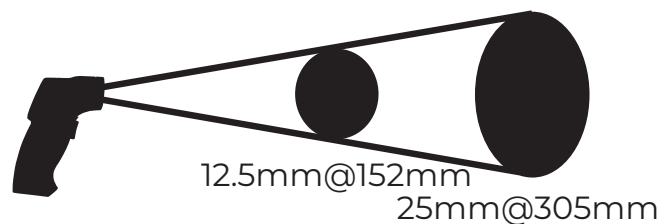

Distance : Spot = 12:1

Understanding 'emissivity'

Emissivity (ϵ) is a value corresponding to how effective a material's surface is at emitting energy as thermal radiation. The Protech IR thermometer senses this infrared radiation and is preset with an

emissivity value of 0.95.

Many materials like rubber, various plastics, wood, food, human skin, dry soil, and water all have emissivity values close to 0.95. Items like these can be measured quite accurately.

Shiny metals with reflective surfaces have much lower thermal emissivity values. For example, aluminium foil has a value of 0.04, new galvanised steel is 0.23, and stainless steel is 0.74. To improve accuracy on these surfaces, cover a small section in electrical tape, white-out or even a piece of paper. They all have emissivity close to 0.95 and are easy to remove once you've finished taking measurements.

How to maximise temperature gun accuracy

Surface temperature measurements are less accurate if taken at an angle. Point the Protech infrared thermometer directly at the surface, so the lens is parallel to the target. Don't forget the sensor detects temperatures at the surface, not internal temperatures.

As long as you can see the item and highlight it with the laser pointer, you can measure it!

Measurement Operation

1. Hold the meter by its Handle Grip and point it toward the surface to be measured.
2. Pull and hold the Trigger to turn the meter on and begin testing. The display will light if the battery is good.
3. Replace the battery if the display does not light.
4. Release the Trigger and the HOLD display icon will appear on the LCD indicating that the reading is being held.
5. In HOLD status, press the laser button to turn on or off the laser. And press the buzzer button to turn on or off
6. The meter will automatically power down after approximately 10 seconds after the trigger is released.

Switching C°/F°: Short press the C°/F° button

Switching Max/Min: Press the Max/Min button.

Switch ON/OFF Laser: Push the Laser/Backlight button once to turn on the laser pointer. Where the laser is on the laser icon will appear on the LCD over the temperature.

Long press the Laser/ Backlight button to turn on/turn off the laser.

Energy Saving Tip

If you've found some surfaces that stand out as being warmer or cooling than others then it's time to investigate why. It could be draughts or it could be better insulation required.

Borrowing a thermal imaging camera can be a good next step to help you easily identify where the issues are.

Safety

- Use extreme caution when the laser beam is turned on.
- Do not let the beam shine onto your or others eyes.
- Be careful not to let the beam reflect off of a surface and into your eyes.
- Do not allow the laser light beam impinge on any gas which can explode.



Emissivities of common materials

The emissivity of a surface is how effective it is at emitting energy as visible light and infrared – what we can see and what we feel as heat.

Emissivity is defined as the ratio of the energy radiated from a material's surface to that radiated from a perfect emitter, known as a blackbody, at the same temperature and wavelength and under the same viewing conditions. It is a dimensionless number between 0 (for a perfect reflector) and 1 (for a perfect emitter).

The emissivity of a surface depends not only on the material but also on the nature of the surface. For example, a clean and polished metal surface will have a low emissivity, whereas a roughened and oxidised metal surface will have a high emissivity. The emissivity also depends on the temperature of the surface as well as wavelength and angle.

Knowledge of surface emissivity is important both for accurate non-contact temperature measurement and for heat transfer calculations. Radiation thermometers detect the thermal radiation emitted by a surface. They are generally calibrated using blackbody reference sources that have an emissivity as close to 1 as makes no practical difference.

Material	Emissivity
Wood	0.85
Water	0.96
Brick	0.75
Stainless Steel	0.14
Adhesive Tape	0.96
Aluminium Plate	0.09
Copper Plate	0.06
Dark Aluminium	0.95
Human Skin	0.98
Asphalt	0.96
PVC Plastics	0.93

Material	Emissivity
Black Paper	0.86
Polycarbonate	0.80
Concrete	0.97
Copper Oxide	0.78
Cast Iron	0.81
Rust	0.80
Gypsum	0.75
Paint	0.90
Rubber	0.95
Soil	0.93